

PDF	MODEL: CR-424
	LENGTH: 8'- 0"

fiberglass

EDON



EDON CORP.

1160 EASTON RD.
HORSHAM, PA 19044
PH: 215/672-8050
TOLLFREE: 800/523-2539
FAX: 215/672-9014
EMAIL: info@edon.com
VISIT US @ www.edon.com

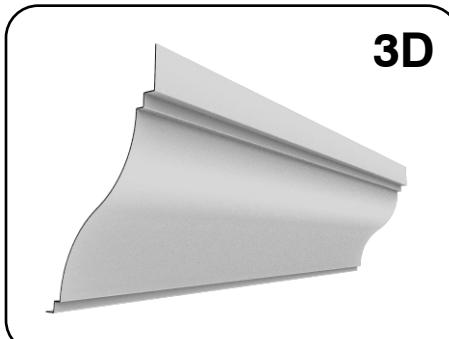

TO VIEW OUR CAD FILES IN .DWG FORMAT, VISIT US ONLINE AND FILL OUT A SHORT FORM TO GAIN ENTRY.